



DIRIS A40/A41

Multifunction meters - PMD

Multi-measurement meter - dimensions 96 x 96 mm

Metering, monitoring & power quality



DIRIS A41

The solution for

- > Industry.
- > Data centres.
- > Infrastructures.



Strong points

- > Easy to use.
- > Detects wiring errors.
- > Customisable.
- > Webserver function.
- > Compliant with IEC 61557-12.

Conformity to standards

- > IEC 61557-12
- > IEC 62053-22 class 0.5S
- > IEC 62053-23 class 2



Function

DIRIS A40 and A41 are panel mounted measurement units which ensure the user has access to all the measurements required for successfully carrying out energy efficiency projects and ensuring the electrical distribution is monitored.

All this information can be analysed remotely using the VERTELIS software solution.

The DIRIS A41 has a CT current input for measuring the neutral current.

Advantages

Easy to use

Thanks to its large backlit LCD display and its multiple viewing screens with direct pushbutton access, DIRIS A4x provide clear readings and are easy to use.

They directly display a number of multi-measurement and metering values : +/- kWh, +/- kvarh, kVAh, I, U, V, F, P, Q, S, PF, etc.

Detects wiring errors

An integrated test function can be utilised to detect incorrect wiring and to automatically correct CT installation errors.

Customisable

Thanks to the wide range of optional modules, the product can be customised or upgraded after installation.

Principle diagram

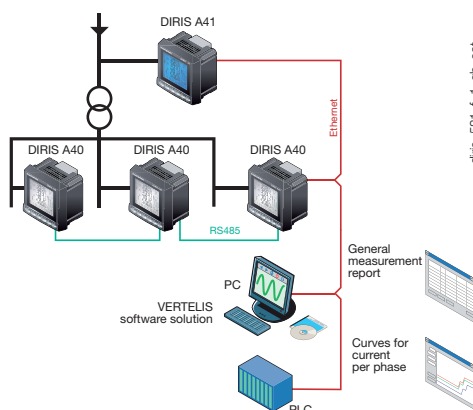

diris_581_f_1_gb_cat

Webserver function

Optional Ethernet communication modules include a Webserver function for monitoring and exploiting data remotely without additional software.

Compliant with IEC 61557-12

IEC 61557-12 is a high-level standard for all PMDs (Performance Monitoring Devices) that are designed to measure and monitor electrical parameters in distribution networks.

Compliance with IEC 61557-12 ensures a high level of equipment performance, in terms of metrology, and the mechanical and environmental aspects (EMC, temperature, etc.).

Functions

Multi-measurement

- Currents
 - instantaneous: I1, I2, I3, In, Isystem
 - average/maximum average: I1, I2, I3, In
- Voltages & frequency
 - instantaneous: V1, V2, V3, U12, U23, U31, F, Vsystem, Ussystem
 - average/maximum average: V1, V2, V3, U12, U23, U31, F
- Power
 - instantaneous: 3P, ΣP, 3Q, ΣQ, 3S, ΣS
 - maximum average: ΣP, ΣQ, ΣS
 - predictive: (ΣP), (ΣQ), (ΣS)
- Power factors
 - instantaneous: 3PF, ΣPF
 - average/maximum average: ΣPF

- Temperatures⁽¹⁾
 - internal
 - external via 3 PT100 sensors

Metering

- Active energy: +/- kWh
- Reactive energy: +/- kvarh
- Apparent power: kVAh
- Hours: ⌚

Harmonic analysis

- Total harmonic distortion
 - Currents: thd I1, thd I2, thd I3, thd In
 - Phase-to-neutral voltage: thd V1, thd V2, thd V3
 - Phase-to-phase voltage: thd U12, thd U23, thd U31

- Individual up to level 63
 - Currents: HI1, HI2, HI3, HIn
 - Phase-to-neutral voltage: HV1, HV2, HV3,
 - Phase-to-phase voltage: HU12, HU23, HU31

Load curves⁽¹⁾

- Active and reactive power: ΣP+/-; ΣQ+/-
- Voltages & frequency: V1, V2, V3, U12, U23, U31, F

Events⁽¹⁾

- Alarms on all electrical values.

Communications⁽¹⁾

- RS485 MODBUS RTU & PROFIBUS DP
- Ethernet (MODBUS TCP or RTU over TCP and Web server)
- Ethernet with RS485 gateway MODBUS RTU over TCP

Inputs / Outputs⁽¹⁾

- Pulse metering
- Remote control/command
- Alarm report
- Pulse report

Analogue output

- 0/4- 20 mA analogue output

⁽¹⁾ Available as an option (see the following pages).

Front panel



1. Backlit LCD display.
2. Direct access key for currents and test function.
3. Direct access key for voltages and frequency.
4. Direct access key for active, reactive, and apparent powers and power factor.
5. Direct access key for maximum and average current and power values.
6. Direct access key for harmonic values.
7. Direct access key for energies, hour meter and programming menu.

Plug-in modules

DIRIS® A40











diris_773_a

DIRIS® A41*

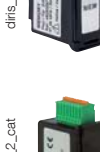

diris_774_a

* with a factory fitted neutral CT module.

 <p>diris_445_a_1_cat</p>	<p>Pulse outputs</p> <p>2 configurable pulse outputs (type, weight and duration) on \pm kWh, \pm kvarh and kVAh.</p>
 <p>diris_447_a_1_cat</p>	<p>Communication MODBUS®</p> <p>RS485 link with MODBUS® protocol (speed up to 38400 bauds).</p>
 <p>diris_775_a_1_cat</p>	<p>PROFIBUS® DP communication</p> <p>SUB-D9 link with PROFIBUS® DP protocol (speed up to 12 Mbauds).</p>
 <p>diris_777_a_1_cat</p>	<p>Ethernet communication</p> <ul style="list-style-type: none"> • Ethernet connection with MODBUS TCP or MODBUS RTU over TCP protocol. • Embedded Webserver function⁽¹⁾.
 <p>diris_776_a_1_cat</p>	<p>Ethernet communication with RS485 MODBUS gateway</p> <ul style="list-style-type: none"> • Ethernet connection with MODBUS TCP or MODBUS RTU over TCP protocol. • Connection of 1 to 247 RS485 MODBUS slaves. • Embedded Webserver function⁽¹⁾.
 <p>diris_448_a_1_cat</p>	<p>Analogue outputs</p> <p>A maximum of 2 modules may be connected, providing up to 4 analogue outputs. Per module 2 outputs assignable to:</p> <p>3I, In, 3V, 3U, F, \pm ΣP, \pm ΣQ, ΣS, ΣPFL/C, I sys, Vsys, Usys, Ppred, Q pred, Spred, T°C internal, T°C 1, T°C 2, T°C3 and to 17 VDC power supply.</p>
 <p>diris_449_a_1_cat</p>	<p>2 inputs - 2 outputs</p> <p>A maximum of 3 modules may be connected, providing up to 6 inputs and 6 outputs. Per module 2 outputs assignable to:</p> <ul style="list-style-type: none"> - monitoring: 3I, In, 3V, 3U, F, \pm ΣP, \pm ΣQ, ΣS, ΣPFL/C, THD 3I, THD In, THD 3V, THD 3U, Ppred, Qpred, Spred, internal T°C, T°C 1, T°C2, T°C3 and hour meter, - remote control, - timed remote control. - 2 inputs for pulse metering.
 <p>diris_662_a_1_cat</p>	<p>Memory</p> <ul style="list-style-type: none"> • Storing up to a maximum of 62 days of P+, P-, Q+, Q- with an internal or external synchronisation signal of 5, 8, 10, 15, 20, 30 and 60 minutes. • Storing of 10 hour-dated last alarms. • Storing of the last minimum and maximum instantaneous values for 3U, 3V, 3I, In, F, ΣP\pm, ΣQ\pm, ΣS, THD 3U, THD 3V, THD, 3U, THD, 3V, THD, 3I, THD In. • Storing of 3U, 3V and F average values based on synchronisation function (maximum 60 days).
 <p>diris_747_a_2_cat</p>	<p>Temperature⁽²⁾</p> <p>Temperature indication:</p> <ul style="list-style-type: none"> - internal, - external sensor PT 100 (T°C 1), - external sensor PT 100 (T°C 2), - external sensor PT 100 (T°C 3).

(1) See "Management software for DIRIS" p. 464.

(2) See "external sensor PT 100" p. 505.

DIRIS A40/A41

Multifunction meters - PMD

Multi-measurement meter - dimensions 96 x 96 mm

Accessories

Current transformers
(see page 488)

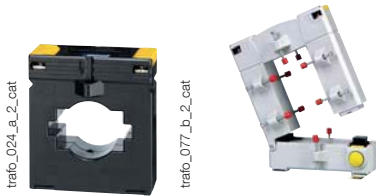

IP65 protection



Panel mounting kit for a 144 x 96 mm cut-out



Terminals

DIRIS A40

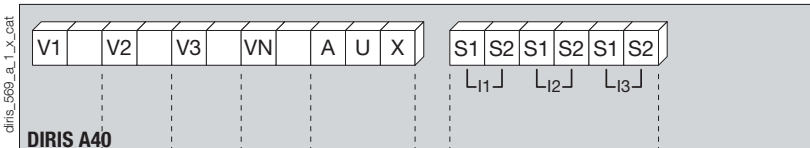

S1 - S2: current inputs

AUX: auxiliary power supplies U_s
V1 - V2 - V3 - VN: voltage inputs

DIRIS A41

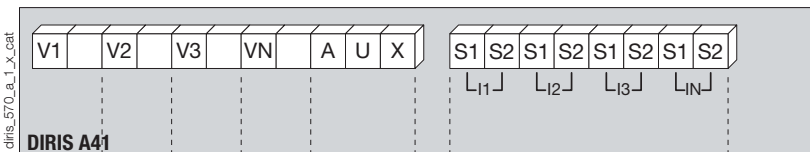

S1 - S2: current inputs

AUX: auxiliary power supplies U_s
V1 - V2 - V3 - VN: voltage inputs

Communication module

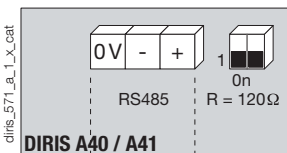

DIRIS A40 / A41

RS485 link.

R = 120 Ω: selectable internal resistance for RS485 end of line termination.

Pulse output module

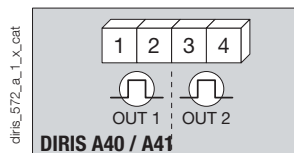

DIRIS A40 / A41

1 - 2: pulse output n°1.
3 - 4: pulse output n°2.

Analogue output module

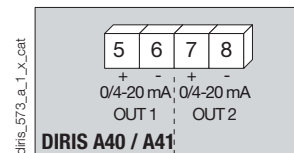

DIRIS A40 / A41

5 - 6: analogue output n°1.
7 - 8: analogue output n°2.

2 inputs / 2 outputs module

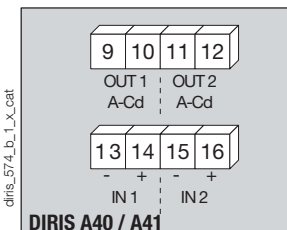

DIRIS A40 / A41

9 - 10: relay output n°1.
11 - 12: relay output n°2.
13 - 14: opto input n°1.
15 - 16: opto input n°2.

Memory module

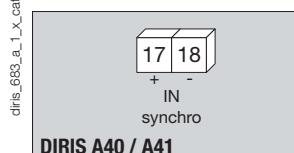

DIRIS A40 / A41

17 - 18: synchronisation input.

Temperature module

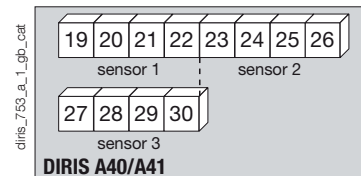

DIRIS A40/A41

Sensor 1 Sensor 2 Sensor 3
19: red 23: red 27: red
20: red 24: red 28: red
21: white 25: white 29: white
22: white 26: white 30: white

Ethernet Module

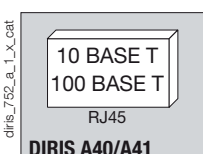

DIRIS A40/A41

Ethernet module + RS485 MODBUS gateway

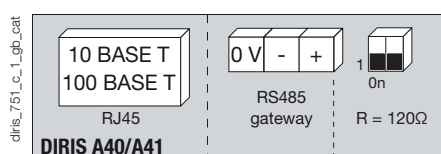

DIRIS A40/A41

Electrical characteristics

Current measurement on insulated inputs (TRMS)	
Via CT primary	9 999 A
Via CT secondary	1 or 5 A
Measurement range	0 ... 11 kA
Input consumption	≤ 0.1 VA
Measurement updating period	1 s
Accuracy	0.2 %
Permanent overload	6 A
Intermittent overload	10 I _n for 1 s
Voltage measurements (TRMS)	
Direct measurement between phases	50 ... 700 VAC
Direct measurement between phase and neutral	28 ... 404 VAC
VT primary	500 000 VAC
VT secondary	60, 100, 110, 173, 190 VAC
Frequency	50 / 60 Hz
Input consumption	≤ 0.1 VA
Measurement updating period	1 s
Accuracy	0.2 %
Permanent overload	800 VAC
Current-voltage product	
Limitation for 1A CT	10 000 000
Limitation for 5A CT	10 000 000
Power measurement	
Measurement updating period	1 s
Accuracy	0.5 %
Power factor measurement	
Measurement updating period	1 s
Accuracy	0.5 %
Frequency measurement	
Measurement range	45 ... 65 Hz
Measurement updating period	1 s
Accuracy	0.1 %
Energy accuracy	
Active (according to IEC 62053-22)	Class 0.5 S
Reactive (according to IEC 62053-23)	Class 2
Auxiliary power supply	
Alternating voltage	110 ... 400 VAC
AC tolerance	± 10 %
Direct voltage	120 ... 350 VDC / 12 ... 48 VDC
DC tolerance	± 20 % / - 6 ... + 20 %
Frequency	50 / 60 Hz
Consumption	≤ 10 VA

2 inputs / 2 outputs module: Outputs (alarms / control)	
Number of relays	2 ⁽¹⁾
Type	250 VAC - 5 A - 1150 VA
2 inputs / 2 outputs module: Phototransistor inputs	
Number	2 ⁽¹⁾
Power supply	10 ... 30 VDC
Minimum signal width	10 ms
Minimum duration between 2 pulses	18 ms
Type	phototransistors
Pulse output module	
Number of relays	2
Type	100 VDC - 0.5 A - 10 VA
Max. number of operations	≤ 10 ⁸
Analogue output module	
Number of outputs	2 ⁽²⁾
Type	insulated
Range	0 / 4 ... 20 mA
Load resistance	600 Ω
Maximum current	30 mA
MODBUS communication module	
Link	RS485
Type	2 ... 3 half duplex wires
Protocol	MODBUS RTU
MODBUS [®] speed	4800 ... 38400 bauds
PROFIBUS-DP communication module	
Link	SUB-D9
Protocol	PROFIBUS [®] DP
PROFIBUS [®] speed	9.8 kbauds ... 12 Mbauds
Ethernet communication module	
Connection	RJ45
Speed	10 base T / 100 base T
Protocol	MODBUS TCP or MODBUS RTU over TCP
Temperature module (inputs)	
Type	PT100
Connection	2, 3 or 4 wires
Dynamic	- 20 °C ... 150 °C
Accuracy	+/- 1 digit
Maximum length	300 cm
Operating conditions	
Operating temperature	- 10 ... + 55 °C
Storage temperature	- 20 ... + 85 °C
Relative humidity	95 %

(1) Max. 3 modules / DIRIS.

(2) Max. 2 modules / DIRIS.

Case

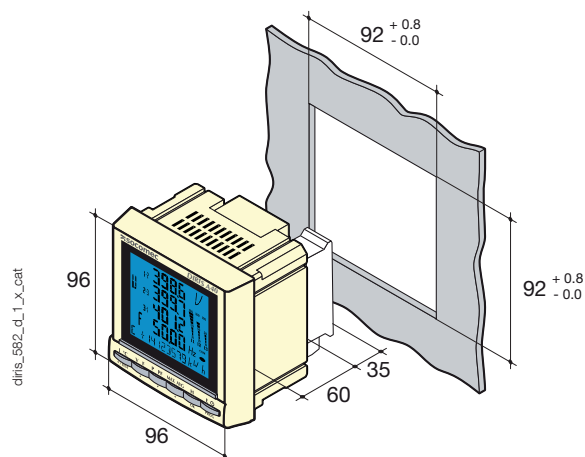

Type	panel mounting
Dimensions W x H x D	96 x 96 x 60 mm
Case degree of protection	IP30
Front degree of protection	IP52
Display type	backlit LCD display
Terminal blocks type	fixed or plug-in
Voltage and other connection cross-section	0.2 ... 2.5 mm ²
Current connection cross-section	0.5 ... 6 mm ²
Weight	400 g

DIRIS A40/A41

Multifunction meters - PMD

Multi-measurement meter - dimensions 96 x 96 mm

Connections

Recommendation: When disconnecting the DIRIS, the secondary of each current transformer must be short-circuited. This operation can be carried out automatically by a SOCOMEC PTI, an accessory which is included in this catalogue. Please consult us. In TNC neutral systems it is recommended to use the functional earth module.

Low voltage balanced network for DIRIS A40

3/4 wires with 1 CT

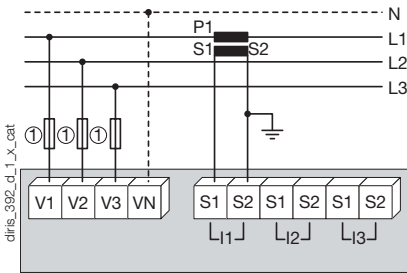

Use of 1 CT reduces by 0.5% the accuracy of the phases, the current of which is worked out by vector calculation.

1. Fuses 0.5 A gG / 0.5 A class CC.

Single-phase

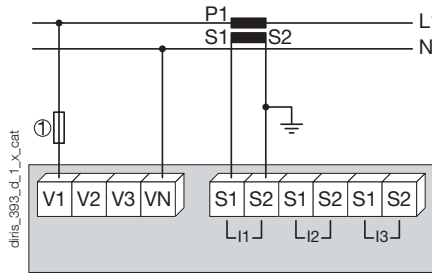

1. Fuses 0.5 A gG / 0.5 A class CC.

Two-phase

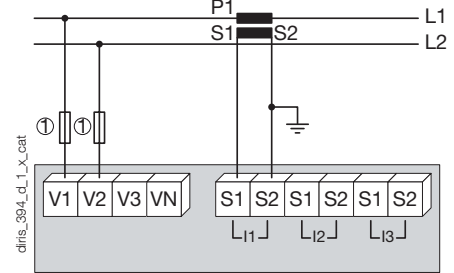

1. Fuses 0.5 A gG / 0.5 A class CC.

Low voltage unbalanced network for DIRIS A40

3/4 wires with 3 CTs

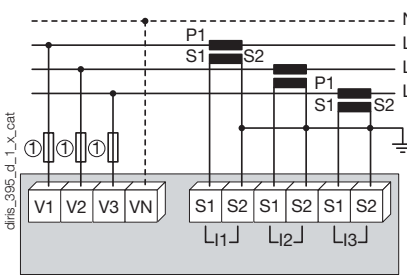

1. Fuses 0.5 A gG / 0.5 A class CC.

3 wires with 2 CTs

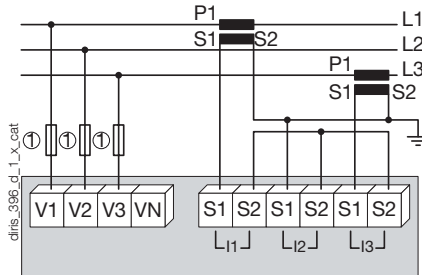

Use of 2 CTs reduces by 0.5% the accuracy of the phases, the current of which is worked out by vector calculation.

1. Fuses 0.5 A gG / 0.5 A class CC.

3 wires with 2 CTs

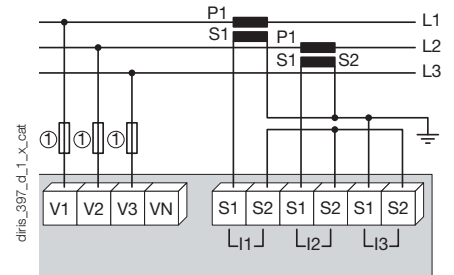

Use of 2 CTs reduces by 0.5% the accuracy of the phases, the current of which is worked out by vector calculation.

1. Fuses 0.5 A gG / 0.5 A class CC.

Low voltage unbalanced network for DIRIS A41

4 wires with 4 CTs

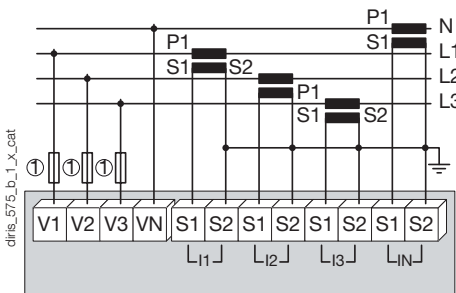

1. Fuses 0.5 A gG / 0.5 A class CC.

Additional information

Communication via RS485 link

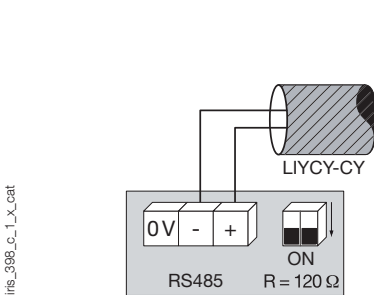

Connection of voltage transformer for HV networks

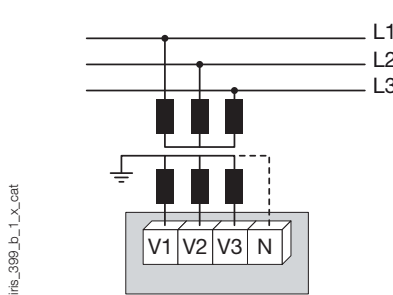

AC & DC auxiliary power supply

110 / 400 VAC (CEI)
120 / 350 VDC (CEI)

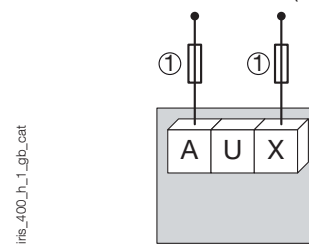

1. Fuses 0.5 A gG / 0.5 A class CC.

References

Basic device	DIRIS A40		DIRIS A41 with CT on the neutral
Auxiliary power supply U_s	Reference		Reference
110 ... 400 VAC / 120 ... 350 VDC	4825 0201		4825 0202
12 ... 48 VDC	4825 1201		4825 1202
Options			
Plug-in modules⁽¹⁾	Reference		Reference
Pulse outputs	4825 0090		4825 0090
RS485 MODBUS [®] communication	4825 0092		4825 0092
Analogue outputs	4825 0093		4825 0093
2 inputs / 2 outputs	4825 0094		4825 0094
Communication Sub D9 PROFIBUS [®] DP ⁽²⁾	4825 0205		4825 0205
Memory	4825 0097		4825 0097
Embedded Webserver function ⁽²⁾ .	4825 0203		4825 0203
Ethernet communication + RS485 MODBUS gateway (Embedded Webserver function) ⁽²⁾	4825 0204		4825 0204
Temperature inputs	4825 0206		4825 0206

(1) Ease of integration for additional functions (maximum 4 slots on A40 and 3 on A41).

(2) Dimension of the plug-in module: 2 slots.

Accessories	To be ordered in multiples of	Reference	To be ordered in multiples of	Reference
Description of accessories				
IP65 protection	1	4825 0089	1	4825 0089
Panel mounting kit for a 144 x 96 mm cut-out	1	4825 0088	1	4825 0088
Fuse disconnect switches for the protection of voltage inputs (type RM) 3 poles	4	5601 0018	4	5601 0018
Fuse disconnect switches for the protection of the auxiliary supply (type RM) 1 pole + neutral	6	5601 0017	6	5601 0017
Fuse type gG 10x38 0.5 A	10	6012 0000	10	6012 0000
Current transformer range	1	See page 488	1	See page 488
Ferrite to be associated with communication modules	1	4899 0011		4899 0011
Temperature sensor PT100 - M6 screw type	1	4825 0208	1	4825 0208
Temperature sensor PT100 - M6 eyelet type	1	4825 0209	1	4825 0209
Management software for DIRIS				See page 464

Services & Technical Assistance

- Technical site audits and solution specification, commissioning, maintenance, training... Our Services & Technical Assistance experts offer you personalised support to ensure success with all your projects.

